



600W Ultra-High Peak Power Supply

**HRP-600N3** series



■ **Features**

- Universal AC input / Full range
- Withstand 300VAC surge input for 5 seconds
- Up to 350% peak power capability
- Built-in constant current limiting circuit
- Protections: Short circuit / Overload / Over voltage / Over temperature
- Built-in cooling fan ON-OFF control
- Built-in DC OK signal
- Built-in remote sense function
- Withstand 5G vibration
- Operating altitude up to 5000 meters(Note.5)
- Output voltage adjustable  $\pm 15\%$ (Avg.)
- 5 years warranty

■ **Applications**

- Industrial automation machinery
- Industrial control system
- Mechanical and electrical equipment
- Diagnostic or biological facilities
- Test or measurement systems
- Telecommunication equipment

■ **GTIN CODE**

MW Search: <https://www.meanwell.com/serviceGTIN.aspx>

■ **Description**

HRP-600N3 series is a 600W single output AC/DC ultra-high peak power supply. This series operates at 85~264VAC input voltage and offers the models with the DC output mostly demanded from the industry. Each model is cooled by the built-in fan with fan ON-OFF control, working for the temperature up to 70°C. Moreover, HRP-600N3 can provide 350% short-duration peak power for motor applications and electromechanical loads requiring much higher power during start-up.

■ **Model Encoding**

**HRP - 600N3 - 24**

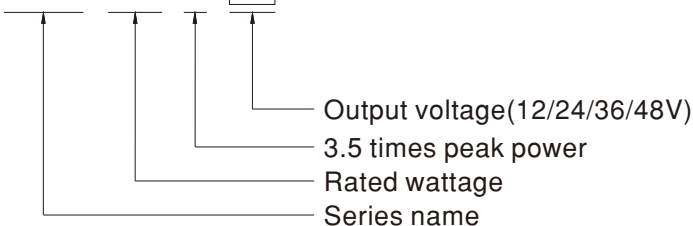



SPECIFICATION

MODEL		HRP-600N3-12	HRP-600N3-24	HRP-600N3-36	HRP-600N3-48	
OUTPUT	DC VOLTAGE	12V	24V	36V	48V	
	RATED CURRENT	53A	27A	17.5A	13A	
	CURRENT RANGE	0 ~ 53A	0 ~ 27A	0 ~ 17.5A	0 ~ 13A	
	RATED POWER	636W	648W	630W	624W	
	RIPPLE & NOISE (max.) <small>Note.2</small>	200mVp-p	150mVp-p	200mVp-p	240mVp-p	
	VOLTAGE ADJ. RANGE	10.2 ~ 13.8V	21.6 ~ 28.8V	28.8 ~ 39.6V	40.8 ~ 55.2V	
	VOLTAGE TOLERANCE <small>Note.3</small>	±1.0%	±1.0%	±1.0%	±1.0%	
	LINE REGULATION	±0.3%	±0.2%	±0.2%	±0.2%	
	LOAD REGULATION	±0.5%	±0.5%	±0.5%	±0.5%	
	SETUP, RISE TIME	1800ms, 50ms/230VAC    3600ms, 50ms/115VAC at full load				
HOLD UP TIME (Typ.)	16ms/230VAC    16ms/115VAC at full load					
INPUT	VOLTAGE RANGE <small>Note.4</small>	85 ~ 264VAC    120 ~ 370VDC				
	FREQUENCY RANGE	47 ~ 63Hz				
	POWER FACTOR (Typ.)	PF>0.94/230VAC    PF>0.98/115VAC at full load				
	EFFICIENCY (Typ.)	88%	88%	89%	89%	
	AC CURRENT (Typ.)	7.6A/115VAC    3.6A/230VAC				
	INRUSH CURRENT (Typ.)	35A/115VAC    70A/230VAC				
LEAKAGE CURRENT	<2mA / 240VAC					
PROTECTION	OVERLOAD	Output power >105% rated for more than 5 seconds then shut down o/p voltage, re-power on to recover Constant current limiting for output power >380% rated for more than 5 seconds and then shut down o/p voltage, re-power on to recover				
	OVER VOLTAGE	14.4 ~ 16.8V	30 ~ 34.8V	41.4 ~ 48.6V	57.6 ~ 67.2V	
	OVER TEMPERATURE	Protection type : Shut down o/p voltage, re-power on to recover Shut down o/p voltage, recovers automatically after temperature goes down				
FUNCTION	DC OK SIGNAL	PSU turn on : 3.3 ~ 5.6V ; PSU turn off : 0 ~ 1V				
	FAN CONTROL (Typ.)	Load 35 ± 15% or RTH2 ≥ 50°C Fan on				
ENVIRONMENT	WORKING TEMP.	-40 ~ +70°C (Refer to "Derating Curve")				
	WORKING HUMIDITY	20 ~ 90% RH non-condensing				
	STORAGE TEMP., HUMIDITY	-40 ~ +85°C, 10 ~ 95% RH non-condensing				
	TEMP. COEFFICIENT	±0.03%/°C (0 ~ 50°C)				
	VIBRATION	10 ~ 500Hz, 5G 10min./1cycle, 60min. each along X, Y, Z axes				
OPERATING ALTITUDE <small>Note.5</small>	5000 meters					
SAFETY & EMC <small>(Note 6)</small>	SAFETY STANDARDS	UL62368-1, TUV BS EN/EN62368-1, EAC TP TC 004, AS/NZS 62368.1 approved				
	WITHSTAND VOLTAGE	I/P-O/P:3KVAC    I/P-FG:2KVAC    O/P-FG:0.5KVAC				
	ISOLATION RESISTANCE	I/P-O/P, I/P-FG, O/P-FG:100M Ohms / 500VDC / 25°C / 70% RH				
	EMC EMISSION	Parameter	Standard		Test Level / Note	
		Conducted	BS EN/EN55032		Class B	
		Radiated	BS EN/EN55032		Class B	
		Harmonic current	BS EN/EN61000-3-2		Class A	
		Voltage Flicker	BS EN/EN61000-3-3		-----	
	EMC IMMUNITY	BS EN/EN55035 , BS EN/EN61000-6-2(BS EN/EN50082-2)				
		Parameter	Standard		Test Level / Note	
		ESD	BS EN/EN61000-4-2		Level 3, 8KV air; Level 2, 4KV contact	
		RF field	BS EN/EN61000-4-3		Level 3, 10V/m	
		EFT/ Burst	BS EN/EN61000-4-4		Level 3, 2KV	
Surge		BS EN/EN61000-4-5		Level 4, 4KV/Line-FG; 2KV/Line-Line		
Conducted		BS EN/EN61000-4-6		Level 3, 10V		
Magnetic Field		BS EN/EN61000-4-8		Level 4, 30A/m		
Voltage Dips and Interruptions	BS EN/EN61000-4-11		95% dip 0.5 periods, 30% dip 25 periods, 95% interruptions 250 periods			
OTHERS	MTBF	1380.2K hrs min. Telcordia TR/SR-332 (Bellcore) ; 191.8K hrs min. MIL-HDBK-217F (25°C)				
	DIMENSION	218*105*61.5mm (L*W*H)				
	PACKING	1.39Kg;8pcs/12.1Kg/1.58CUFT				
NOTE	<p>1. All parameters NOT specially mentioned are measured at 230VAC input, rated load and 25°C of ambient temperature.</p> <p>2. Ripple &amp; noise are measured at 20MHz of bandwidth by using a 12" twisted pair-wire terminated with a 0.1uf &amp; 47uf parallel capacitor.</p> <p>3. Tolerance : includes set up tolerance, line regulation and load regulation.</p> <p>4. Derating may be needed under low input voltages. Please check the derating curve for more details.</p> <p>5. The ambient temperature derating of 3.5°C/1000m with fanless models and of 5°C/1000m with fan models for operating altitude higher than 2000m(6500ft).</p> <p>6. The power supply is considered a component which will be installed into a final equipment. All the EMC tests are been executed by mounting the unit on a 360mm*360mm metal plate with 1mm of thickness. The final equipment must be re-confirmed that it still meets EMC directives. For guidance on how to perform these EMC tests, please refer to "EMI testing of component power supplies." (as available on <a href="http://www.meanwell.com">http://www.meanwell.com</a> )</p> <p>※ Product Liability Disclaimer : For detailed information, please refer to <a href="https://www.meanwell.com/serviceDisclaimer.aspx">https://www.meanwell.com/serviceDisclaimer.aspx</a></p>					



600W Ultra-High Peak Power Supply

**HRP-600N3 series**

■ Block Diagram

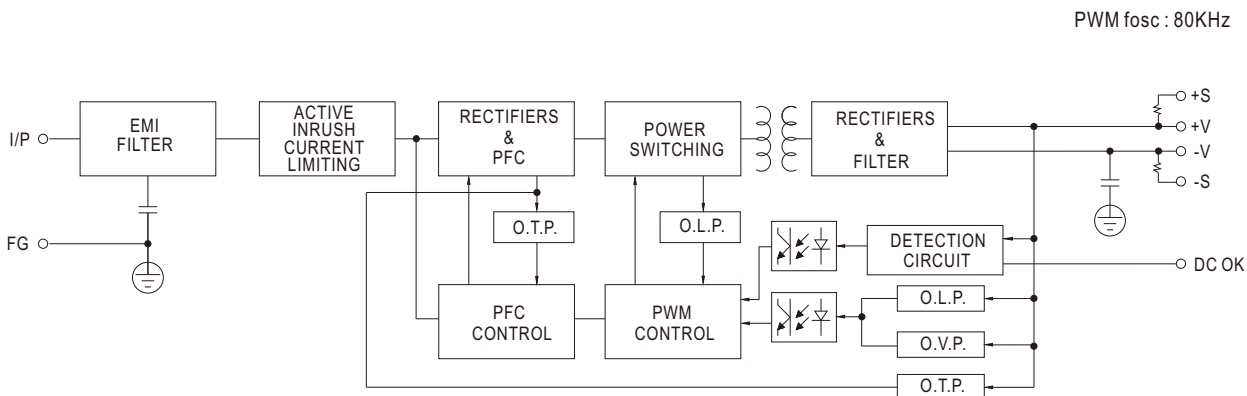

■ Derating Curve

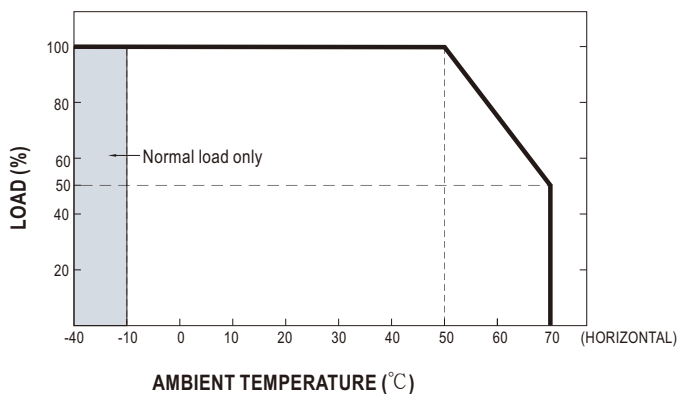

■ Output Derating VS Input Voltage

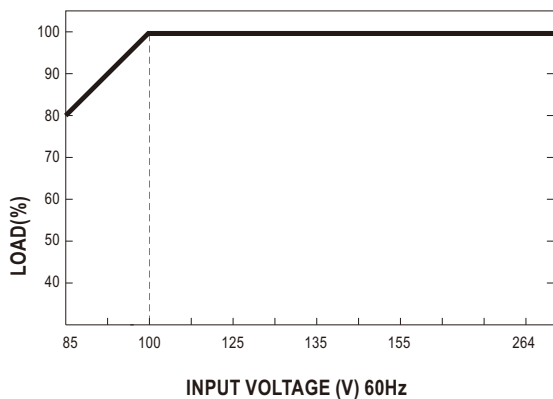



600W Ultra-High Peak Power Supply

**HRP-600N3 series**

■ **Function Manual**

**1. Peak Power**

$$P_{av} = \frac{P_{pk} \times t + P_{npk} \times (T-t)}{T} \leq P_{rated}$$

$$Duty = \frac{t}{T} \times 100\% \leq 35\%$$

$P_{av}$ : Average output power (W)

$P_{pk}$ : Peak output power (W)

$P_{npk}$ : Non-peak output power (W)

$P_{rated}$ : Rated output power (W)

$t$ : Peak power width (sec)

$T$ : Period (sec)

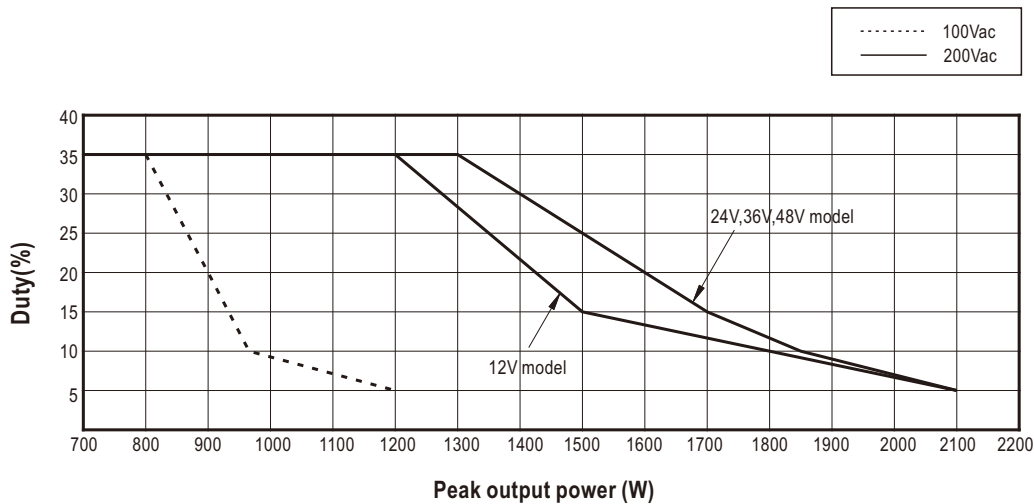
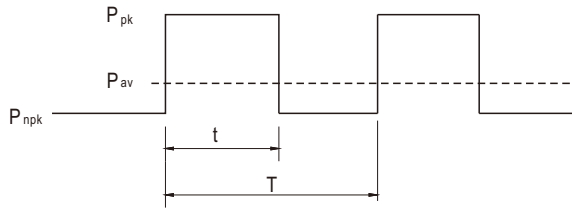

**For example (24V model) :**

$V_{in} = 200V$      $Duty_{max} = 25\%$

$P_{av} = P_{rated} = 648W$

$P_{pk} = 1500W$

$t \leq 5 \text{ sec}$

$$T \geq \frac{5 \text{ sec}}{25\%} \geq 20 \text{ sec}$$

$$P_{npk} \leq \frac{T P_{av} - t P_{pk}}{T-t}$$

$P_{npk} \leq 364W$



600W Ultra-High Peak Power Supply

**HRP-600N3 series**

**2.Remote Sense**

The remote sensing compensates voltage drop on the load wiring up to 0.5V.

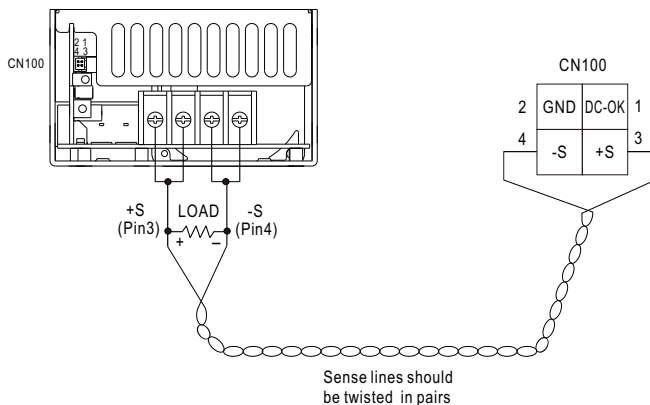

Fig 1.1

**3.DC-OK Signal**

DC-OK signal is a TTL level signal. High when PSU turns on.

Between DC-OK(pin1) and GND(pin2)	Output Status
3.3 ~ 5.6V	ON
0 ~ 1V	OFF

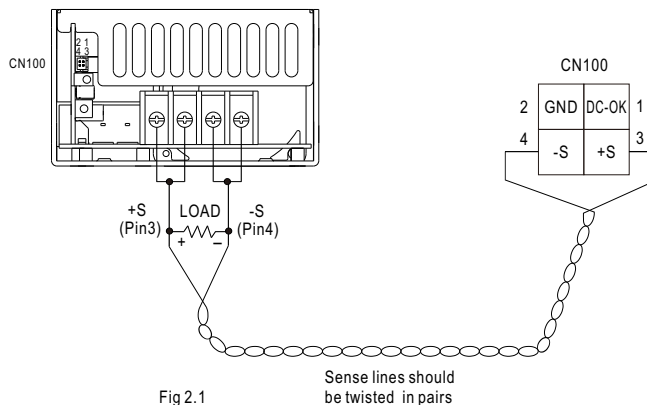

Fig 2.1



## 600W Ultra-High Peak Power Supply

# HRP-600N3 series

### ■ Mechanical Specification

Case No. 977G Unit:mm

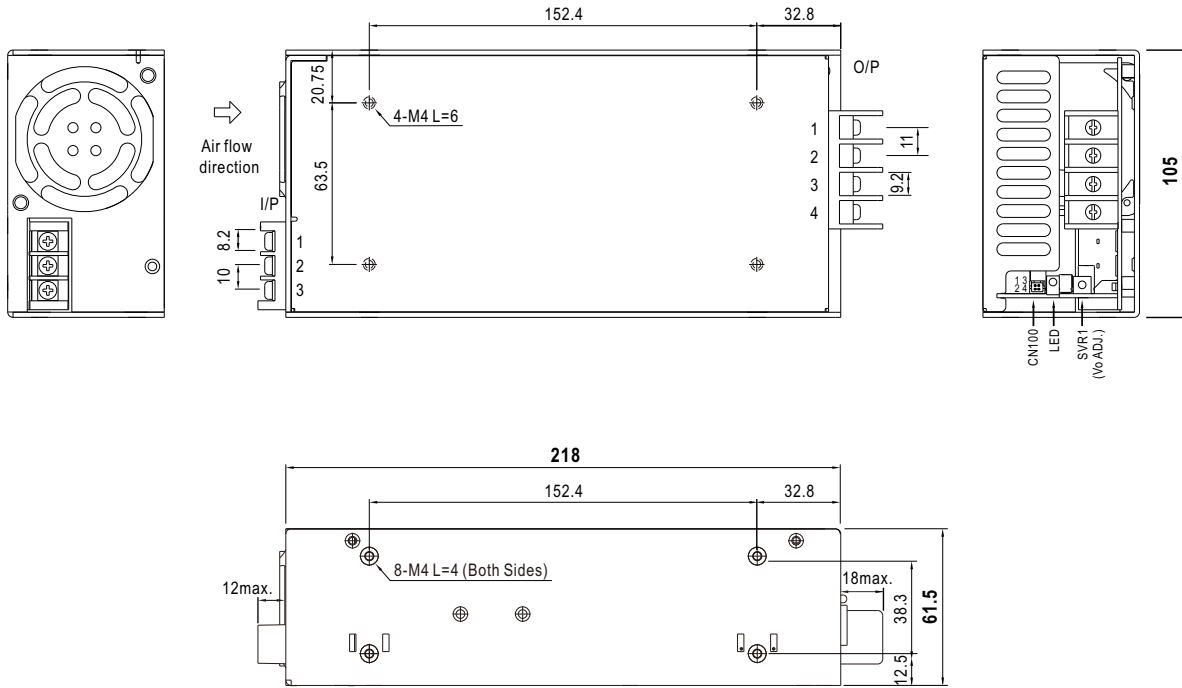

#### AC Input Terminal Pin No. Assignment

Pin No.	Assignment
1	AC/L
2	AC/N
3	FG $\perp$

#### DC Output Terminal Pin No. Assignment

Pin No.	Assignment
1~2	-V
3~4	+V

#### Connector Pin No. Assignment(CN100) : HRS DF11-4DP-2DS or equivalent

Pin No.	Assignment	Mating Housing	Terminal
1	DC-OK	HRS DF11-4DS or equivalent	HRS DF11-**SC or equivalent
2	GND		
3	+S		
4	-S		

### ■ Installation Manual

Please refer to : <http://www.meanwell.com/manual.html>