



■ Features :

- Universal AC input / Full range
- Fully isolated plastic case with IP64 level
- Built-in constant current limiting circuit with adjustable OCP level
- Protections: Short circuit / Overload / Over voltage
- Optional dimming function : 1.1~10VDC (D type) or PWM (P type) controlled
- UL1310 Class 2 power unit
- Cooling by free air convection
- 100% full load burn-in test
- Suitable for LED lighting and moving sign applications
- Low cost
- 2 years warranty

SPECIFICATION

IP64 CE

MODEL	ELN-30-5	ELN-30-9	ELN-30-12	ELN-30-15	ELN-30-24	ELN-30-27	ELN-30-48	
OUTPUT	DC VOLTAGE	5V	9V	12V	15V	24V	27V	48V
	LED OPERATION VOLTAGE Note.7	3 ~ 5V	3 ~ 9V	3 ~ 12V	3 ~ 15V	3 ~ 24V	3 ~ 27V	3 ~ 48V
	RATED CURRENT	5A	3.4A	2.5A	2A	1.25A	1.12A	0.63A
	CURRENT RANGE	0 ~ 5A	0 ~ 3.4A	0 ~ 2.5A	0 ~ 2A	0 ~ 1.25A	0 ~ 1.12A	0 ~ 0.63A
	RATED POWER	25W	30.6W	30W	30W	30W	30.24W	30.24W
	RIPPLE & NOISE (max.) Note.2	80mVp-p	100mVp-p	120mVp-p	120mVp-p	150mVp-p	150mVp-p	250mVp-p
	VOLTAGE ADJ. RANGE	4.5 ~ 5.5V	8.7 ~ 10.5V	10.8 ~ 13.2V	13.5 ~ 16.5V	21.6 ~ 26.4V	24.3 ~ 29.7V	43.2 ~ 52.8V
	Can be adjusted by internal potential meter SVR1							
	CURRENT ADJ. RANGE	-25% ~ 3%. Can be adjusted by internal potential meter SVR2						
	VOLTAGE TOLERANCE Note.3	±5.0%						
	LINE REGULATION	±1.0%						
	LOAD REGULATION	±2.0%						
INPUT	SETUP, RISE TIME Note.6	500ms, 80ms / 230VAC 1000ms, 80ms / 115VAC at full load						
	HOLD UP TIME (Typ.)	50ms/230VAC 16ms/115VAC at full load						
	VOLTAGE RANGE	90 ~ 264VAC						
	FREQUENCY RANGE	47 ~ 63Hz						
	EFFICIENCY (Typ.)	75%	80%	82%	82%	85%	85%	87%
PROTECTION	AC CURRENT	0.75A/115VAC 0.48A/230VAC						
	INRUSH CURRENT(max.)	COLD STAR 60A/230VAC						
	LEAKAGE CURRENT	0.25mA / 240VAC						
	OVER CURRENT Note.4	95 ~ 110%						
	OVER VOLTAGE	Protection type : Constant current limiting, recovers automatically after fault condition is removed						
FUNCTION	WORKING TEMP.	5.75 ~ 6.75V 11 ~ 13.5V 13.8 ~ 16V 17.5 ~ 21V 28 ~ 32V 31 ~ 36.4V 54 ~ 60V						
	WORKING HUMIDITY	Protection type : Shut down o/p voltage, re-power on to recover						
	STORAGE TEMP., HUMIDITY	1 ~ 10VDC or PWM						
	TEMP. COEFFICIENT	-20 ~ +60°C (Refer to output load derating curve)						
	VIBRATION	20 ~ 90% RH non-condensing						
SAFETY & EMC	SAFETY STANDARDS	-40 ~ +80°C, 10 ~ 95% RH						
	WITHSTAND VOLTAGE	±0.03%/°C (0 ~ 50°C)						
	ISOLATION RESISTANCE	10 ~ 500Hz, 2G 10min./1cycle, period for 60min. each along X, Y, Z axes						
	EMI CONDUCTION & RADIATION	Design refer to UL1310 Class 2, TUV EN60950-1, CAN/CSA C22.2 No. 223-M91(except for 48V), EN61347-2-13; IP64 approved						
	HARMONIC CURRENT	I/P-O/P:3KVAC						
	EMS IMMUNITY	I/P-O/P:>100M Ohms / 500VDC / 25°C / 70% RH						
OTHERS	MTBF	Compliance to EN55022 (CISPR22) Class B						
	DIMENSION	Compliance to EN61000-3-2,-3						
	PACKING	Compliance to EN61000-4-2,3,4,5,6,8,11; ENV50204, EN55024, light industry level, criteria A						
NOTE	MTBF	628.3Khrs min. MIL-HDBK-217F (25°C)						
	DIMENSION	145*47*30mm (L*W*H)						
	PACKING	0.26Kg; 60pcs/16.6Kg/1.25CUFT						
	NOTE	<ol style="list-style-type: none"> 1. All parameters NOT specially mentioned are measured at 230VAC input, rated load and 25°C of ambient temperature. 2. Ripple & noise are measured at 20MHz of bandwidth by using a 12" twisted pair-wire terminated with a 0.1uf & 47uf parallel capacitor. 3. Tolerance : includes set up tolerance, line regulation and load regulation. 4. Derating may be needed under low input voltage. Please check the derating curve for more details. 5. The power supply is considered a component which will be installed a final equipment. The final equipment must be re-confirmed that it still meets EMC directives. 6. Length of set up time is measured at first cold start. Turning ON/OFF the power supply may lead to increase of the set up time. 7. Constant current operation region is within the specified output voltage range above. This is the suitable operation region for LED related applications. 						

Mechanical Specification

Case No.964A Unit:mm

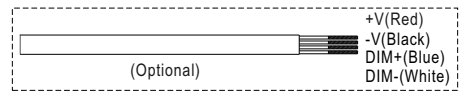
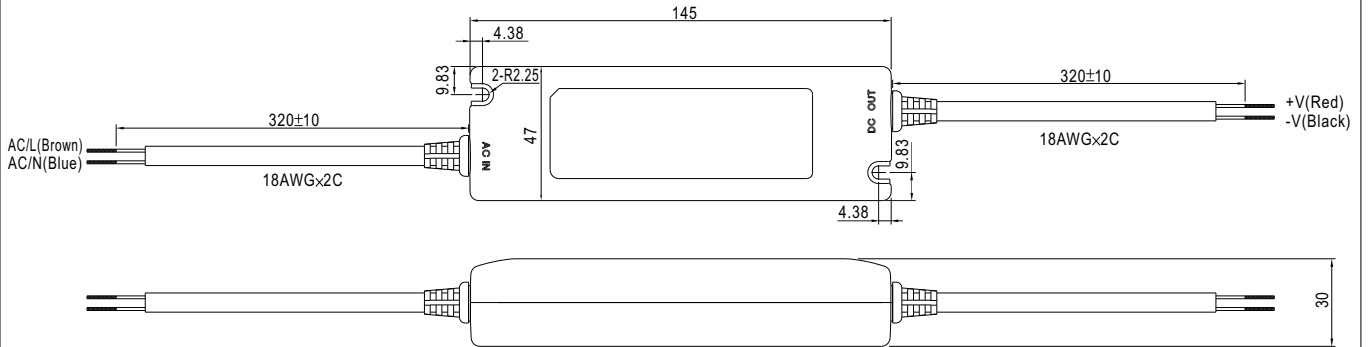

Output voltage and current adjustment : remove the upper case and adjust through SVR1 & SVR2 shown in the diagram.

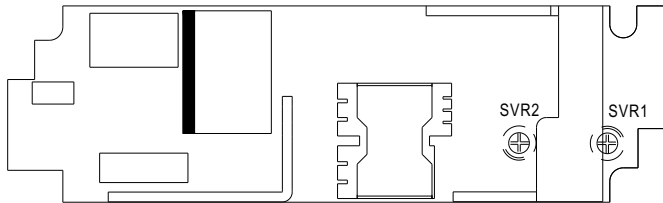

Block Diagram

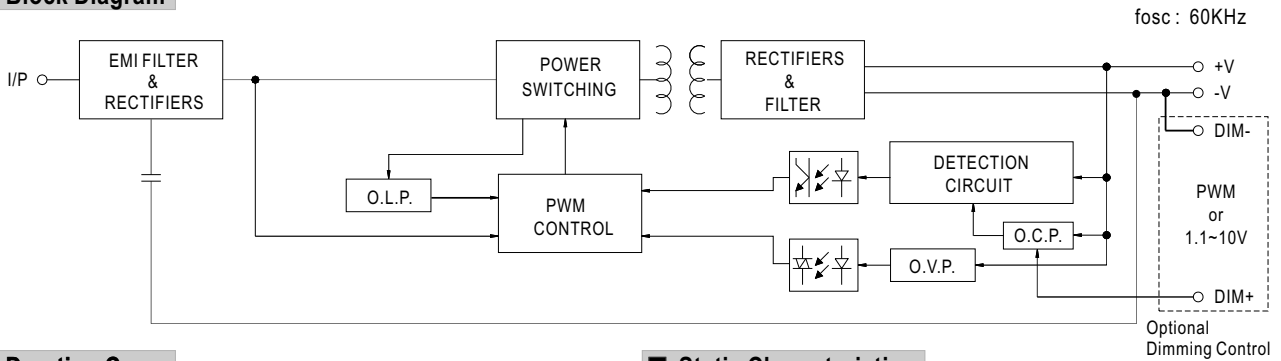

Derating Curve

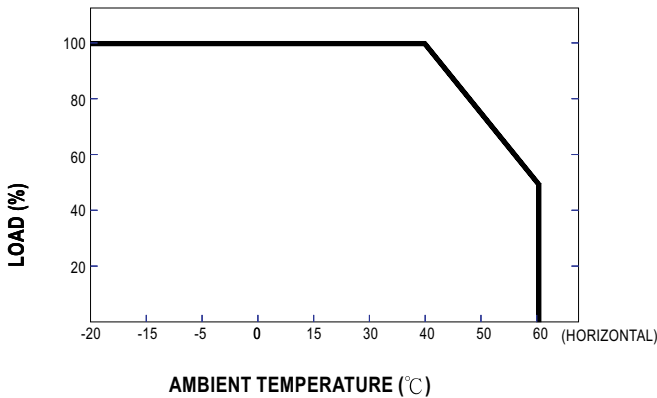

Static Characteristics

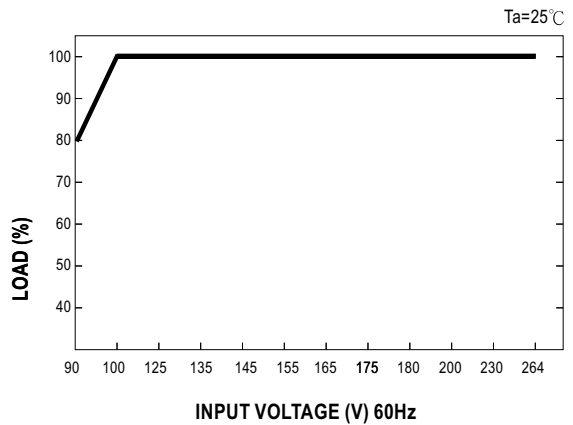

Dimming Control (Optional)

Level of output current can be adjusted through the dimming control function.

(1) 1.1~10V

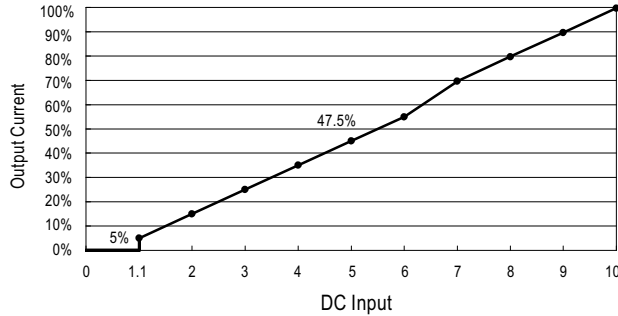
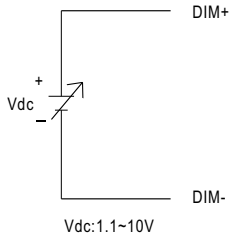

(2) PWM

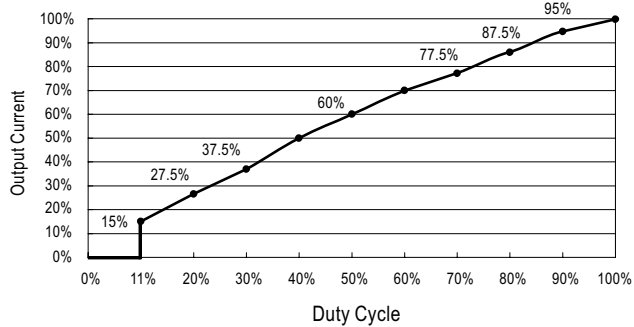
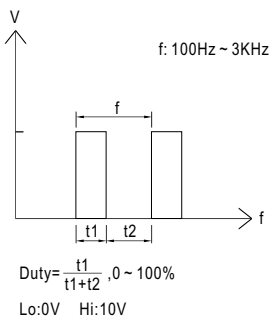

Recommend Application Deployment (24V)

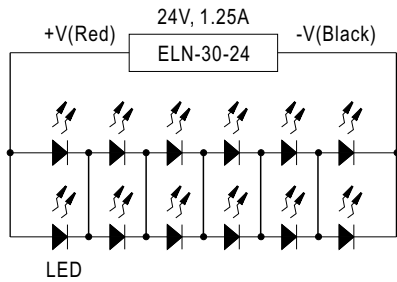

1 to 6 LEDs // 2 strips
 This configuration is based on LED with the following parameters :
 $V_f = 3.0 \sim 3.5\text{V}$ $I_f = 600 \sim 700\text{mA}$

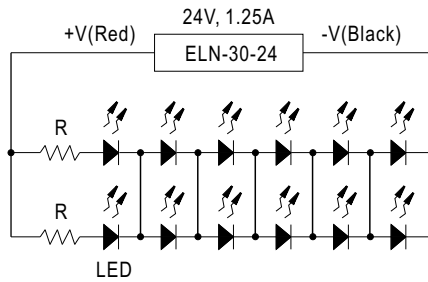

6 LEDs // 1 to 2 strips
 This configuration is based on LED with the following parameters :
 $V_f = 3.0 \sim 3.5\text{V}$ $I_f = 600 \sim 700\text{mA}$
 $R = 10 \text{ ohm}, 10\text{W}$

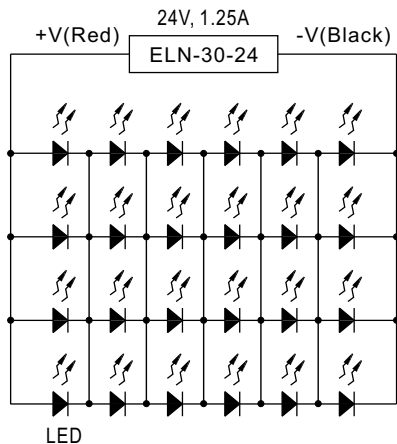

1 to 6 LEDs // 4 strips
 This configuration is based on LED with the following parameters :
 $V_f = 3.0 \sim 3.5\text{V}$ $I_f = 300 \sim 350\text{mA}$

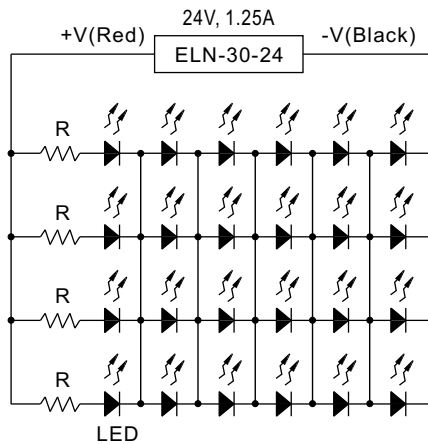

6 LEDs // 1 to 4 strips
 This configuration is based on LED with the following parameters :
 $V_f = 3.0 \sim 3.5\text{V}$ $I_f = 300 \sim 350\text{mA}$
 $R = 20 \text{ ohm}, 3\text{W}$